

14-3Y65・14-3Y100・14-3Y150/15-3Y500・15-3Y500(ﾌﾟﾗﾝ-)・15-3Y2000B

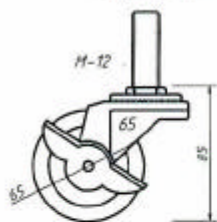

14-3Y65  
30K ストッパー付タイプ

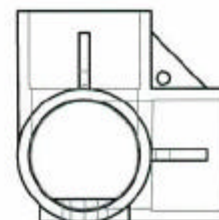
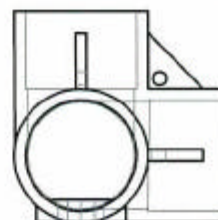
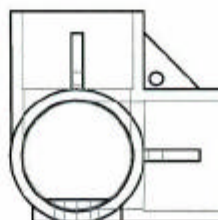
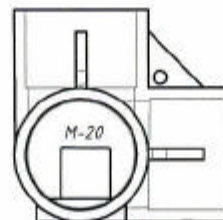
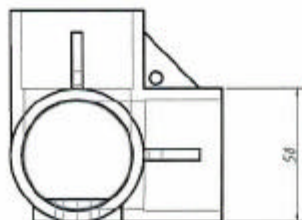
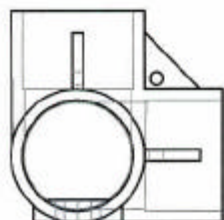
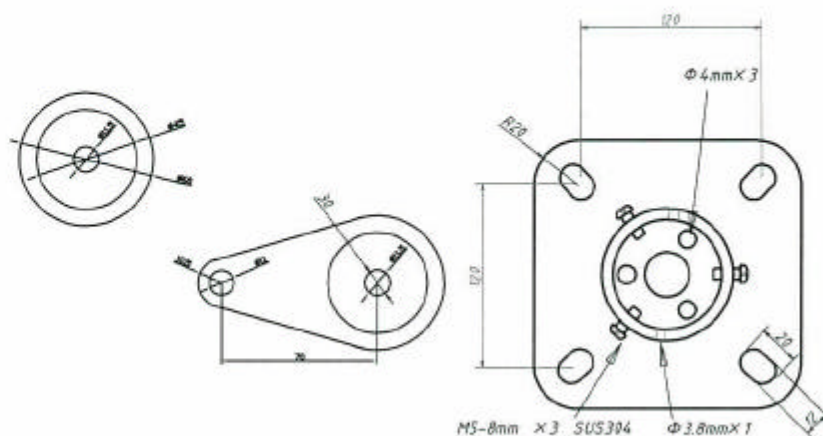
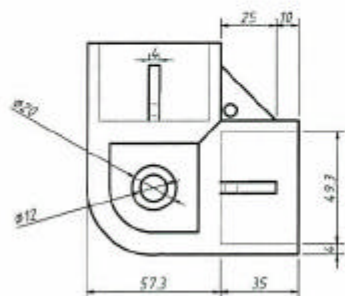
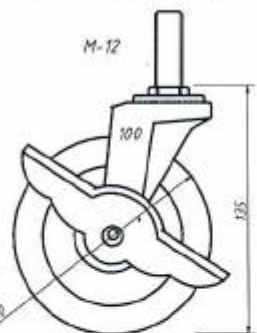

14-3Y100  
50K ストッパー付タイプ

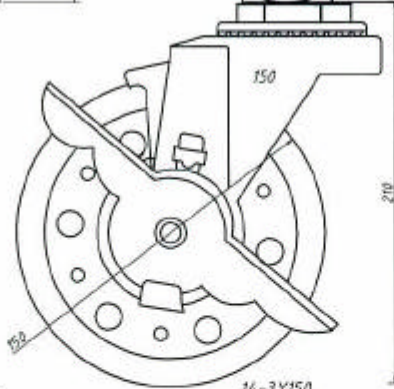

14-3Y150  
160K ストッパー付タイプ

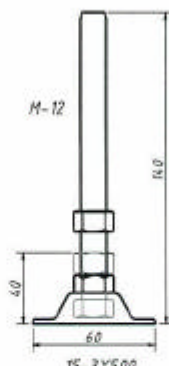

15-3Y500  
水平調整 85mm 500kタイプ

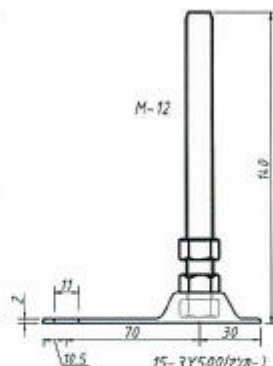

15-3Y500(ﾌﾟﾗﾝ-)  
水平調整 85mm 500kタイプ

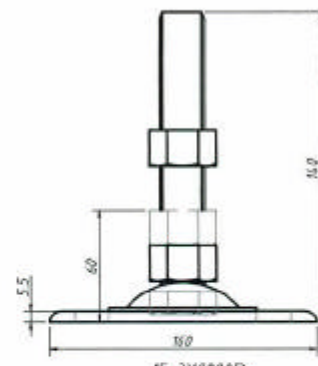

15-3Y2000B  
水平調整 70mm 2t タイプ

FILM NAME	F-999-20100511 Auto CAD
DRAWN	N-3Y65・N-3Y100・N-3Y150・15-3Y500・15-3Y500(ﾌﾟﾗﾝ-)・15-3Y2000B
CHECK	
APPR	joint kogyo T.okano
ISSUED	